

FULLWHITE
MANUAL

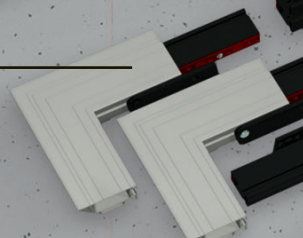
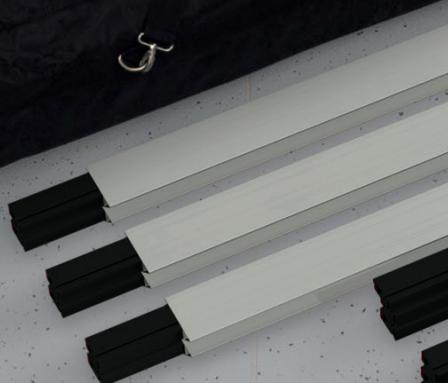

CORNER ELEMENTS

4 pieces- basic frame 52x52 cm
(fig.: including SET UP SUPPORT, optional)

CENTRE SUPPORT

Consists of plug in-elements with integrated screw-connection

ACCESSORY BAG

Yellow bag for mounting accessories

PROJECTION SCREEN BAG

Lined storage bag for folded projection screen
(Optional transport tube for rolled delivery)





SOFTBAG WITH WHEELS

padded , tearproof nylonbag
with wheels and carrying straps
small 128x25x30 cm
big 133x31x35 cm
(optional Flightcase)

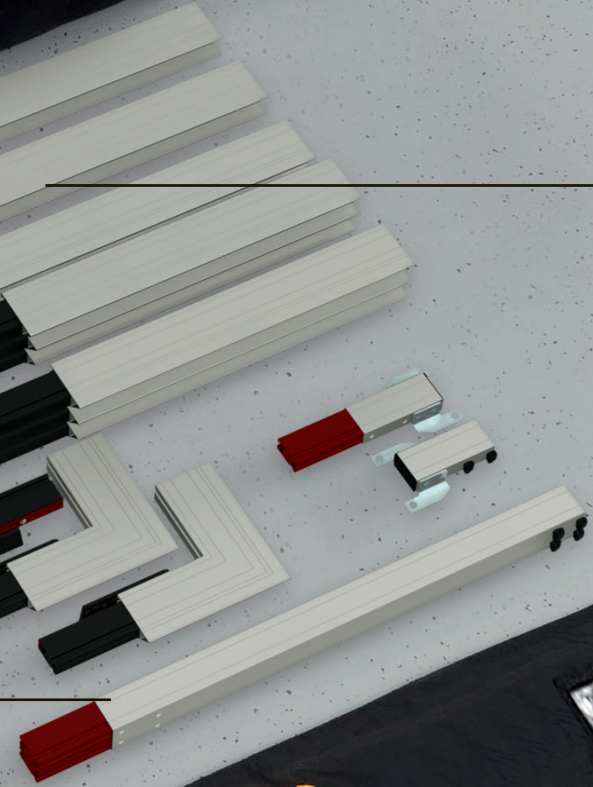

FULLWHITE FRAME

Modular plug-in frame system
Basic frame (4 corners 52x52 cm),
Frame components in custom length
Fullwhite compact: standard and
supplementary frame components
in short lengths for small transport volume



ASSEMBLY INSTRUCTION

INDEX

| | |
|---------------------------------------|----|
| SCOPE OF DELIVERY | 2 |
| GENERAL | 5 |
| OVERVIEW | 6 |
| FULLWHITE FRAME COMPONENTS | 7 |
| CLAMP CONNECTION | 8 |
| FRAME MOUNTING WITH SET UP SUPPORT | 10 |
| CENTER SUPPORT | 11 |
| PIVOT NUTS | 13 |
| ATTACHMENT OF SET UP SUPPORT | 13 |
| MOUNTING OPTIONS | 14 |
| FRAME MOUNTING WITHOUT SET UP SUPPORT | 15 |
| ACCESSORIES | 16 |



GENERAL

QUALITY AND SAFETY:

This projection screen is in accordance with the safety regulations in DIN standard 19045 and DIN 56950. The screen fabric is comply with DIN 4102 part 1 and the specifications of the according data sheet.

WARRANTY:

The warranty period for production deficiencies is 5 years for the frame elements and 24 months for the projection surface. The projection screen is developed for indoor use only. Any damage and consequential damage caused by outdoor use is not covered by warranty.

FRAME ELEMENTS:

The frame elements, accessories and additional elements are maintenance-free!

PROJECTION SURFACE:

The projection surface is packed into a separate soft bag to avoid any damage by the frame parts, bleaching and discoloration. Additionally following handling instructions have to be adhered to:

! Do not bring printed and coloring objects (instructions, magazines, etc.) in contact with the projection surface

! Do not mark the projection surface!

Colors penetrate the projection surface and cannot be cleaned anymore!

Store the projection surface cleaned and dry at room temperature only!

When transporting the projection surface at low temperatures, do not mount the surface unless it has reached its full elasticity at room temperature. Otherwise there is the risk of cold break of the projection screen.

FOLDED STORAGE

The projection surface has to be folded with the front layer inside and we recommend to lay out the enclosed foamed plastic foil between the surface layers to avoid permanent marks, soil and damage.

ROLLED STORAGE

Packing the projection surface we recommend to lay out the enclosed foamed plastic foil between the surface layers to avoid permanent marks.

CLEANING OF THE PROJECTION SURFACE:

Use a white clean cotton cloth saturated with clear water (optionally mild soap water) and wipe the area gently in one direction (no circular motion). Wipe dry with another cotton cloth.

To clean a stubborn stain, use methylated spirit and follow the same procedure.

Clean rear projection surfaces in case of imperative only!

Subject to modifications, errors expected !

OVERVIEW

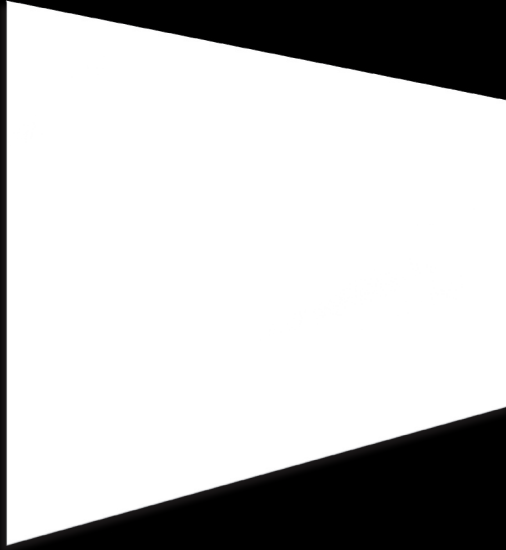

Further development of the mobile projection screens for applications where hidden technology and puristic design is required.

With the minimalistic design this projection screen fits easily in every optical superior installation.

Universal, invisible mounting options as well as high stability and flexibility are essential features of this projection system.

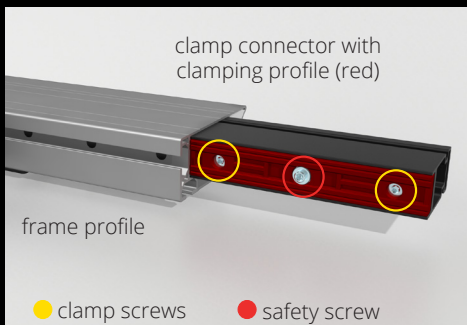

SYSTEM COMPONENTS:

The hollow chamber profile with trapezoid shape gives an extra high stability and allows a perfect wrinkle-free application of the projection surface on the backside of the profile with hooks or Velcro.

The clamp connectors with the patented shape of the clamping profile (red) guarantees a secured and solid connection, like a monolithic system.

The corner parts are designed as a single piece construction with a minimum tolerance, thereby ensuring the highest precision.

FULLWHITE FRAME COMPONENTS

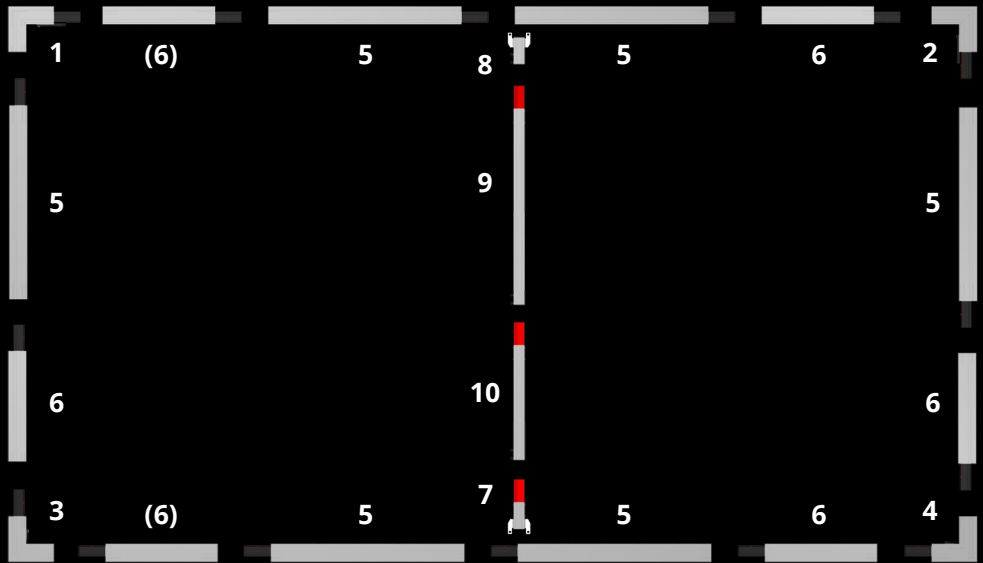

FULLWHITE

All components of the projection screen are labeled. For assembly, start with the basic frame. Place the corner elements 1 to 4 according to drawing above. Afterwards separate the frame components to „horizontal“ and „vertikal“ and halve the number for each frame site.



or



FULLWHITE compact

For small component lengths we recommend the frame assembly according to the following description: Insert the standard elements 5 (110cm) and supplementary frame components 6 (smaller than 110cm) according to their labeling (see sketch above). In case of two supplementary frame components 6 and (6) per frame side, the standard elements 5 (110cm) have to be placed in between of the two supplementary frame components 6 and (6).

CLAMP CONNECTION

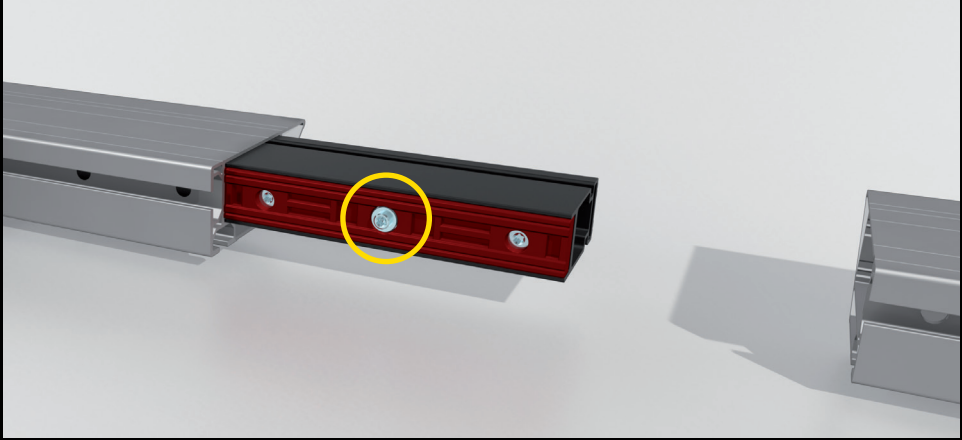

The Fullwhite clamp connector is equipped with a center safety screw.

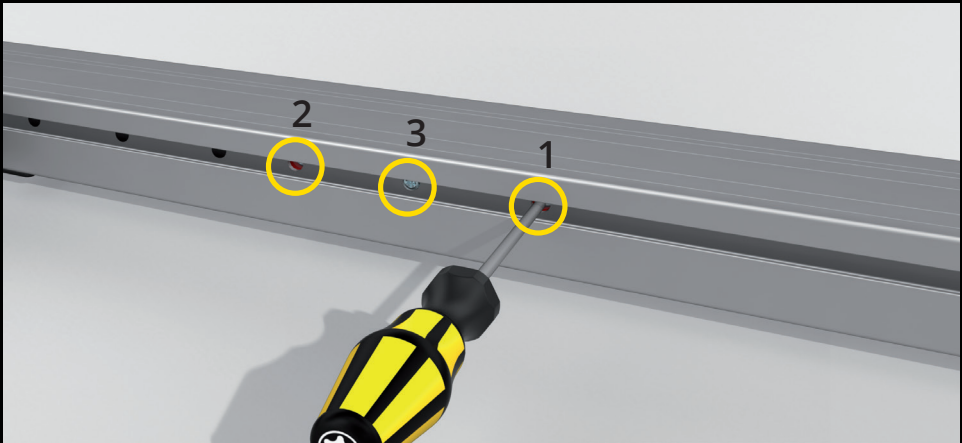

The clamp connection is tightened with the two screws (1&2) and additionally secured with a center safety screw (3). Therefore use the included TORX screwdriver TX25.

FRAME MOUNTING WITH SET UP SUPPORT

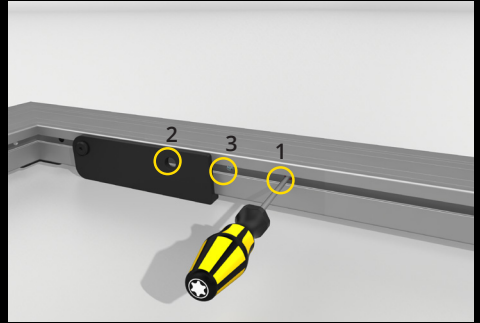
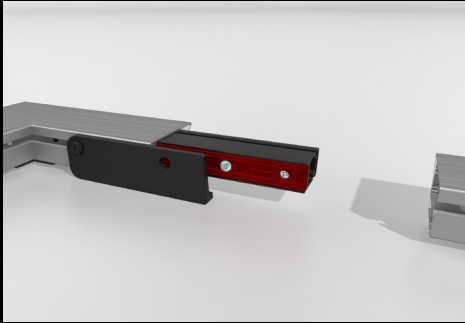

PROTECTIVE FOIL

Before you unroll the projection surface with the projection side down, the floor has to be cleaned completely and the supplied protective foil has to be laid out.

The protective foil is to prevent dirt and damage of the projection surface.

FRAME MOUNTING

Detailed instruction for SET UP SUPPORT (optional accessory) on page 13

NOTE: SET UP SUPPORTS can remain folded up on the frame after mounting.

All components of the projection screen are labeled. For assembly, start with the basic frame. Place the corner elements 1 to 4 according to drawing above. Afterwards separate the frame components to „horizontal“ and „vertikal“ and halve the number for each frame site.

Put together the connected upper and lower horizontal frame elements with corner parts on each end. Clamp the connection by turning the two clamp screws clockwise and secure the connections with the center safety screw. Next plug in the vertical elements, clamp and secure them in the same way. The vertical connections must always be secured with the center safety screw!

In order to meet international safety requirements during flying applications the clamp connection must be locked with the integrated safety screw.

CENTER SUPPORT

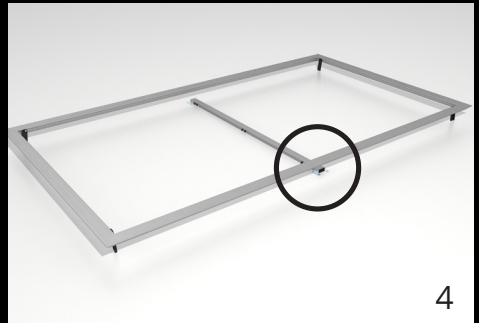
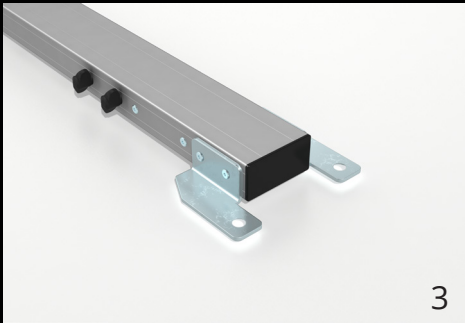
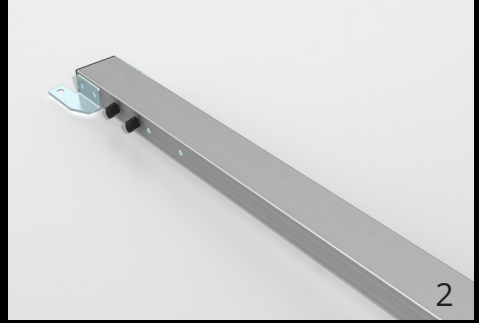
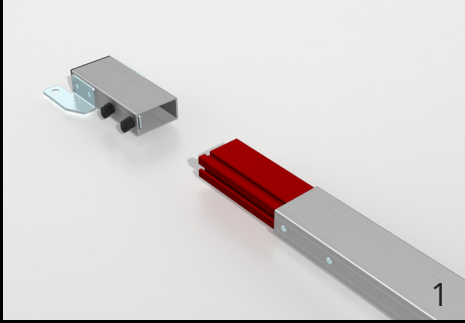

1-2 Put together the center support according to the labels and secure the connections with the two wing nuts.

3 Detach the pivot nuts from the top and bottom center support element and insert them into the inner slot of the horizontal frame bar. (For the insertion of the pivot nut refer to page 13)

4-5 Place the center support and secure it on top and bottom with the Phillips screws. Screwdriver not included.



SURFACE ATTACHMENT

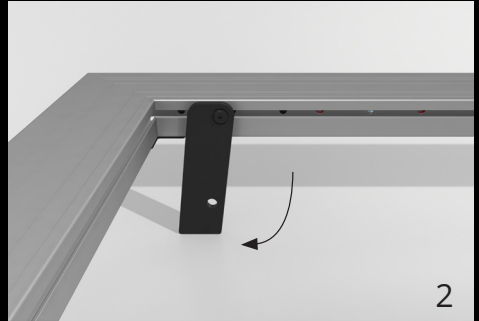
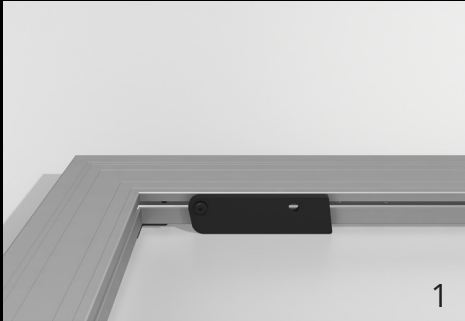

1-2 Foldaway legs hold the projection screen's frame in position above the floor to allow the surface attachment from top.

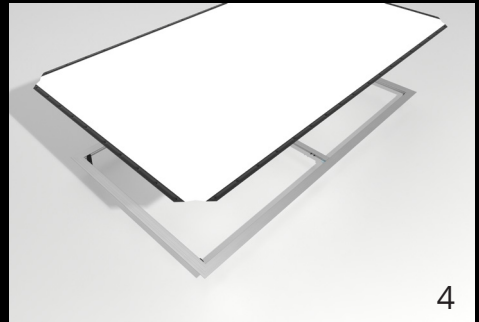
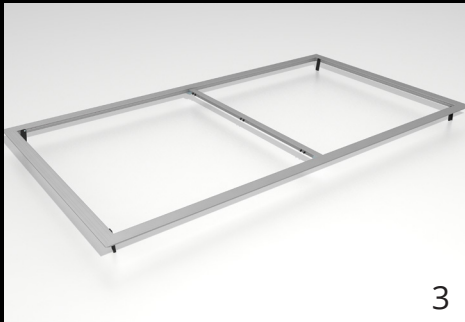

3-4 Lay out the surface on the frame with the label „OBEN-TOP“ corresponding with the upper frame bar. It is necessary to carry out this step with several people to avoid damage of the projection surface.



5-6 Attach the surface by starting at the first corner to fix one vertical and horizontal hook to the corner clip. Repeat this step according to the order in picture **7**.

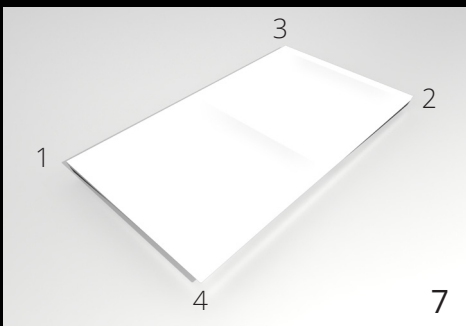

Finally stretch all the remaining hooks one by one over the profile edge and put them into the bottom profile slot.

! Please mind the instructions for projection surfaces in chapter GENERAL on page 5!

PIVOT NUTS

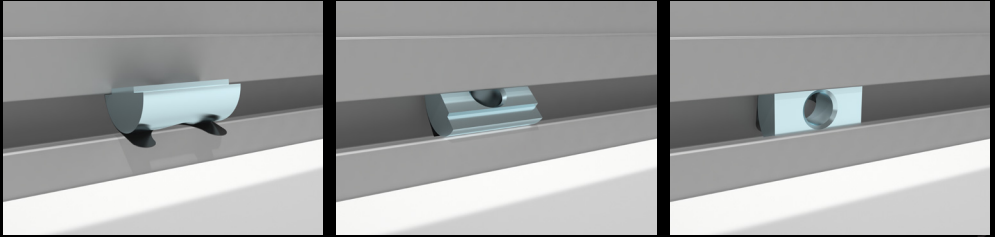

General attachment of pivot Nuts M8 with flexible tongue
(Different to the illustration above, the pivot Nuts M8 for SET UP SUPPORT is equipped with a spring loaded ball)

ATTACHMENT OF SET UP SUPPORT

The installation of the projection surface with large FULLWHITE is done by using SET UP SUPPORTS. Those foldaway legs hold the frame approx. 12 cm above the floor to allow the surface attachment from top.

Laying out the projection surface and the frame on the ground is no longer necessary.
NOTE: SET UP SUPPORTS can remain folded up on the frame after mounting.

The SET UP SUPPORTS are attached to each corner and the remaining ones should be mounted regularly on the horizontal and vertical bars .

Insert the pivot nut into the frame slot and position the SET UP SUPPORT according to the picture below. The additional opening of the SET UP SUPPORT has to be aligned with the screw of the clamp connector to get access for tightening.

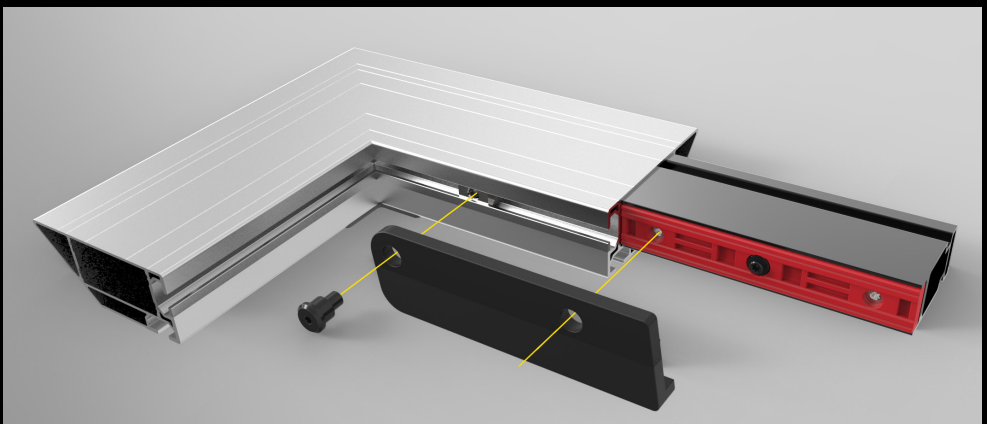

MOUNTING OPTIONS



MOUNTING BRACKET FOR WALL MOUNTING

Optional as vertical or horizontal mounting point

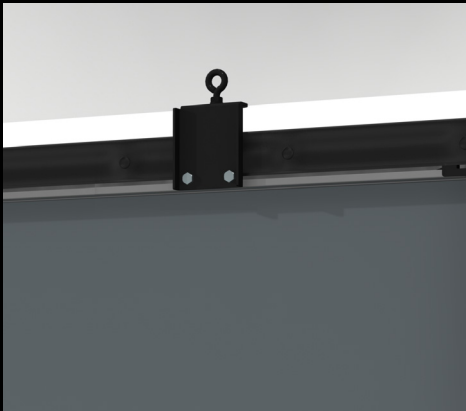

MOUNTING BRACKET FOR CEILING SUSPENSION



MOUNTING POINT FOR LEGS:

Individually movable mounting points with M8 threaded inserts for legs can be mounted at the back of the frame profile.

FRAME MOUNTING WITHOUT SET UP SUPPORT

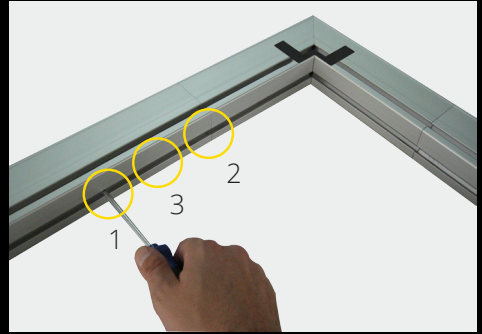
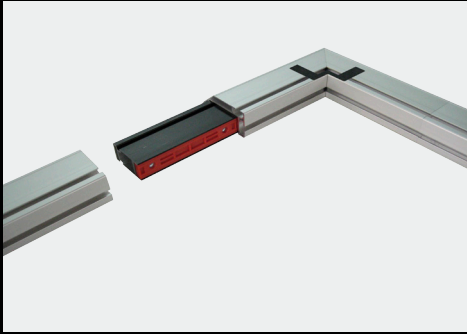

In case of frame mounting without SET UP SUPPORT the profiles have to be placed on the floor with the profile groove to the top .

PROTECTIVE FOIL

Before you unroll the projection surface with the projection side down, the floor has to be cleaned completely and the supplied protective foil has to be laid out.

The protective foil is to prevent dirt and damage to the projection side of the projection surface.

SURFACE MOUNTING

The frame now needs to be placed flat onto the backside of the projection surface according to the photo. This step has to be carried out with several people to avoid any damage of the projection surface!

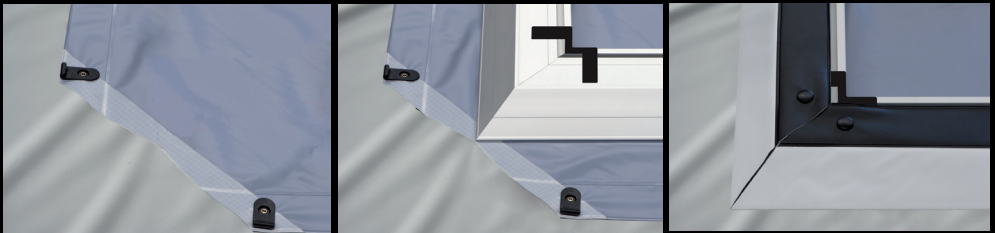

PROJECTION SURFACE WITH HOOKS

Fold the surface to the backside of the frame, tighten it and fix it with the hooks in the slot. The projection surface is kept in position by the special corner clips.

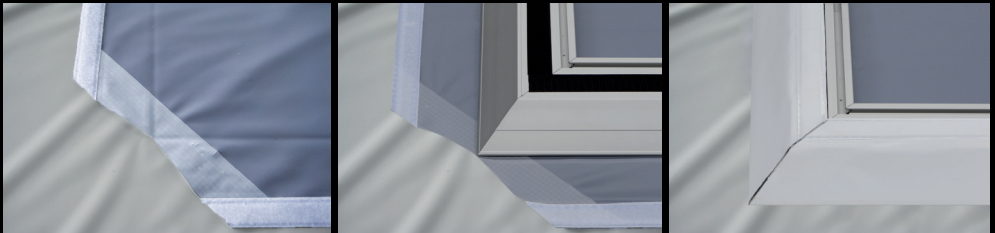

PROJECTION SURFACE WITH VELCRO

Fold the surface to the backside of the frame and tighten it with the Velcro.

ACCESSORIES

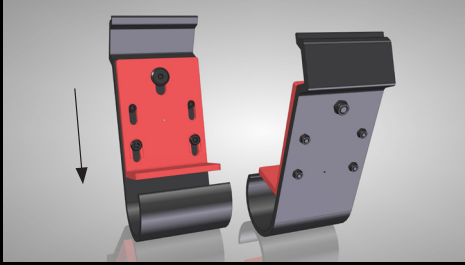

RAISING SUPPORT

The interlock of the raising support has to be secured by pulling back the red angle bracket.

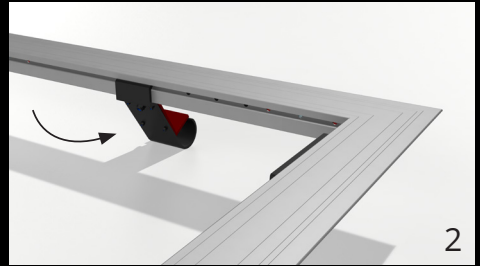
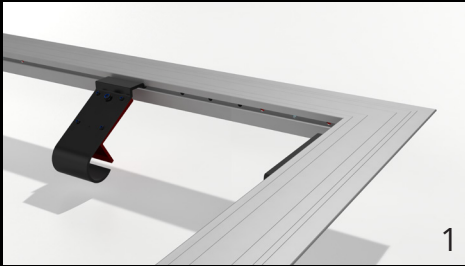

The raising support has to be placed into the inner groove **1** and turned outwards. Doing so will release the interlock and the angle will slide in the bottom groove and secures the raising support **2**. When the surface has been attached to the Fullwhite® projection screen frame and the screen needs to be raised these devices keep the projection screen away from the floor to prevent damaging of the sensitive surface **3**.

CONNECTION BRACKETS AND CONNECTION PLATES

To connect Fullwhite frames, several types of connection are available on request.

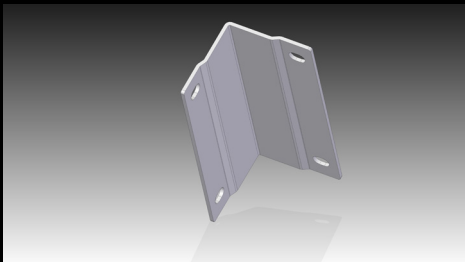

Example 1: Connection bracket outside corner 90°

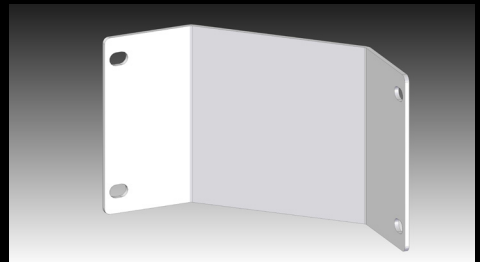

Example 2: Connection bracket inner corner

